

Use and Maintenance Technical Manual



Scan QR Code and visit the website to see more details about our products



Emme Antincendio S.r.l.
www.emme-italia.com

Via del Molino, 40 - 52010 Corsalone (AR) - Italy - info@emme-italia.com - Tel. +39.0575.511320
Other branches Emme Antincendio s.r.l. in Italia : Milano - Padova - Roma - P.IVA/ C.F. 11208251006 - R.E.A. FI-632545

23058-72: Portable Fire Extinguisher, 5 Kg Carbon Dioxide



OPTIONAL



- **CYLINDER**
Alloy steel, external powder coating, color Red Ral 3000.
- **EXTINGUISHING AGENT**
Carbon Dioxide 99,99 % (CO₂)
- **VALVE**
Levian M. 25x2, brass body, lever red RAL 3000.
- **USE**
Fire Rating class B (flammable liquids)

Note: image is for illustrative purpose only, the product purchased can has some difference

5 Kg Carbon Dioxide Fire Extinguisher, operating temperature from -30 ° C to + 60 ° C, built in accordance with the standard **UNI EN 3-7 (D.M. 7.1.2005)**, approved by Marine Equipment Directive **MED 2014/90/UE**, certified according to Pressure Equipment Directive **PED 2014/68/EU**.

All fire extinguishers are voluntarily certified with a Product Quality control guaranteed by Bureau Veritas Italia. Can be used on live electrical equipment up to 1'000 V, at a minimum distance of 1 meter.

APPROVED/CERTIFIED FIRE EXTINGUISHER:

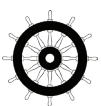

FIRE RATING:



89

© REPRODUCTION IS PROHIBITED

File name	Type of document	Fire Extinguisher Model	Date	Rele.	Check	Rev.	Pag.
23058-72_Technical manual	Use and Maintenance technical manual	23058-72	08/05/2023	M.R		1	1 di 7

23058-72: Portable Fire Extinguisher, 5 Kg Carbon Dioxide

TECHNICAL SPECIFICATIONS

FIRE RATING	89 B
EXTINGUISHING AGENT	Carbon Dioxide 99,99 % (CO ₂)
TEMPERATURE RANGE	-30°C / +60°C
NOMINAL CHARGE	5 Kg
FULL WEIGHT	~ 13,65 Kg
DIMENSIONS	Height (base - valvole) 740 +/- 10 mm Diameter (cylinder) 136 +/- 2 mm
DISCHARGE TIME	~ 11,7 seconds
VALVE TIGHTENING TORQUE	Minimum 60 Nm, Maximum 75 Nm
CYLINDER PRESSURE TEST	PT 250 bar
CYLINDER VOLUME	7,5 L.
SAFETY DEVICE	Set between 186 and 212 bar
CYLINDER MATERIAL	Alloy steel
EXTERNAL/INTERNAL TREATMENT	Sandblasting and powder coating Red Ral 3000

PACKAGING

(Note: the packaging quantities and measurements are indicative and can be subject at changes)

STANDARD

Maximum nr. 65 pieces for pallet
(65 pieces for box, 1 box for pallet)
Pallet dimensions 100x120x100(h) cm

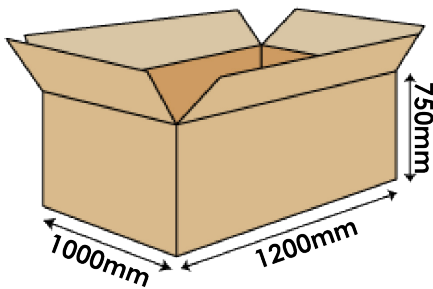

ON REQUEST: SINGLE PACKAGING

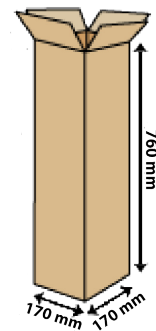

TRANSPORT DISPOSAL

Land transport : Exemption for the purposes of ADR 594

Ship Transport : IMDG Code - UN 1044 class 2.2 Fire Extinguishers

File name	Type of document	Fire Extinguisher Model	Date	Rele.	Check	Rev.	Pag.
23058-72_Technical manual	Use and Maintenance technical manual	23058-72	08/05/2023	M.R		1	2 di 7

23058-72: Portable Fire Extinguisher, 5 Kg Carbon Dioxide

COMPONENTS AND SPARE PARTS LIST

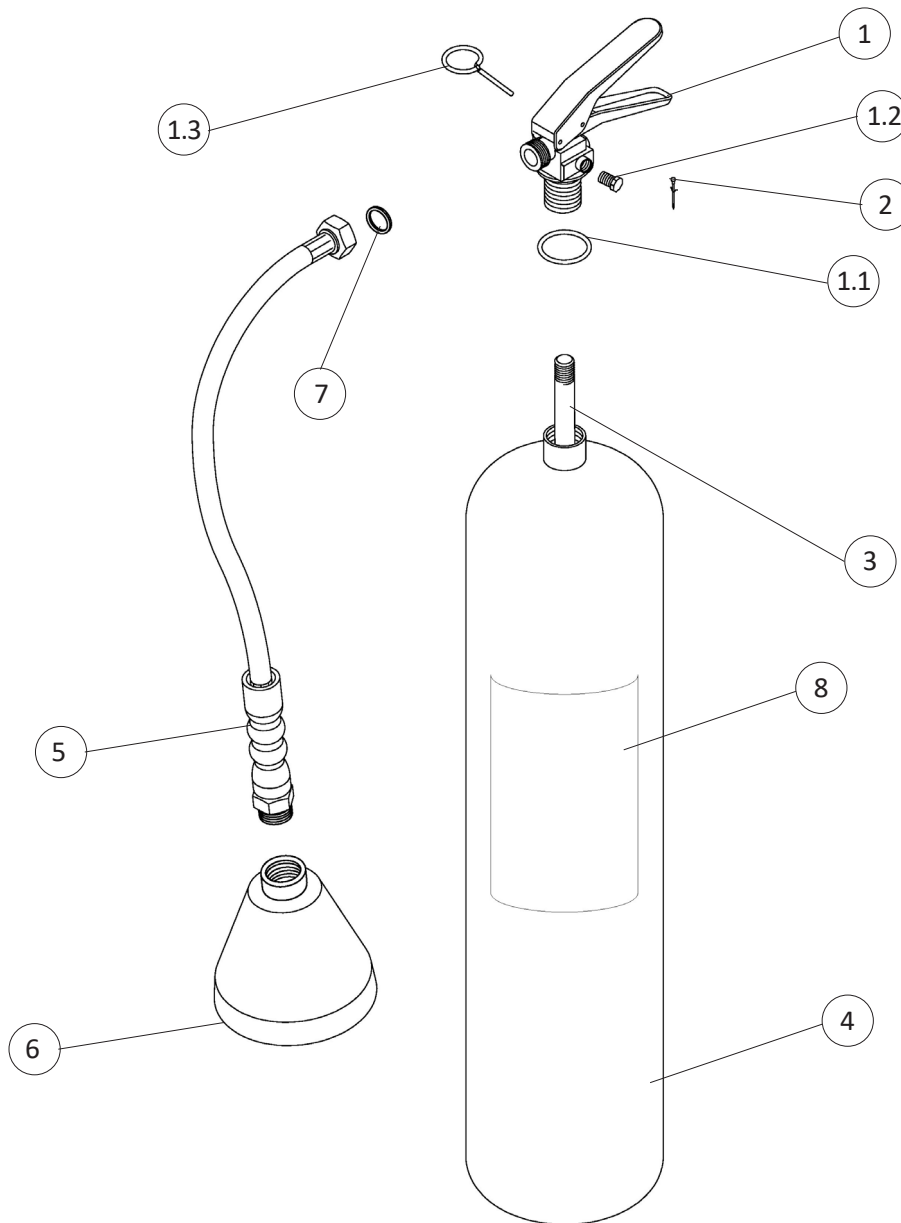

Table 1

NUM.	DESCRIPTION	CODE
1	Valve M. 25x2	0213L
1.1	O-ring valve	0202
1.2	Safety device	n.a.
1.3	Safety pin	0284
2	Safety pin seal (green)	0285
3	Aluminum dip tbe	0160-4
4	Cylinder	0110-1
5	Hose SAE 100 R1 T ½"	0294
6	Dispensing horn	0332-42

NUM.	DESCRIPTION	CODE
7	Gasket in nylon	0204
8	Label	2254-72
OPTIONAL	Iron ring wall-mounted, red painting, Europe model	1907-2
OPTIONAL	Iron marine bracket red painting	0319

The spare part at number 1 includes already all others components indicated from 1.1 to 1.3
 "n.a." mean that the component is not available as single spare part

File name	Type of document	Fire Extinguisher Model	Date	Rele.	Check	Rev.	Pag.
23058-72_Technical manual	Use and Maintenance technical manual	23058-72	08/05/2023	M.R		0	3 di 7

23058-72: Portable Fire Extinguisher, 5 Kg Carbon Dioxide

1) GENERAL PRESCRIPTIONS

All Fire Fighting Fire Extinguishers produced by Emme Antincendio must be installed, inspected and maintained in accordance with the following manual and with the rules in force in the country of destination.

All fire extinguishers must be recharged after partial use with original spare parts.

Every ordinary / extraordinary maintenance operation must be carried out using original spare parts and compliant with the declared certified prototype. The described below maintenance operations must be carried out by recognized personnel qualified by the company Emme Antincendio.

Fire extinguishers are classified into two categories that provide for specific construction standards:

- portable fire extinguishers: fire extinguishers designed to be transported and operated by hand, with a mass not exceeding 20 kg under operating conditions. Reference standard: EN 3-7
- wheeled fire extinguishers: wheel fire extinguishers designed to be transported and operated by hand, with a mass greater than 20 kg. Reference standards: EN 1866-1

Moreover, in relation to the extinguishing agent contained in them, they are identified in:

- water based fire extinguishers including foam extinguishers;
- powder fire extinguishers;
- carbon dioxide fire extinguishers;
- clean agent extinguishers

2) REFERENCE RULES

All Fire Fighting extinguishers produced by Emme Antincendio are manufactured in compliance with the following rules:

- EN 3-7: 2008 Portable fire extinguishers;
- EN 1866-1: 2008 Wheeled fire extinguishers;
- PED Directive 2014/68/EU pressure equipment;
- MED Directive 2014/90/EU devices for marine use (only for products bearing the relative MED certification mark, see pag 1 of this document)

3) INSTALLATION

- 1) Install the fire extinguishers with the appropriate bracket, with the handle at a maximum recommended height of 110 cm.
- 2) When installed in a vehicle the fire extinguisher must be held in a specific truck bracket.
- 3) Do not expose the fire extinguisher to the atmospheric agents or chemicals agents.
(Note: in these cases protect the fire extinguisher with a special cabinet or protective cover.)
- 4) Do not expose the fire extinguisher to the direct sunlight.
- 5) Keep children away from fire extinguisher.
- 6) For Marine equipment or outdoor installation we recommend use of cover or cabinet.

4) MODALITY AND PRECAUTIONS FOR THE USE

- 1) Follow the operative instructions reported in the marking label stamped on the body of the extinguisher:

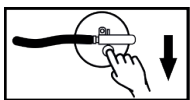

1) REMOVE SAFETY PIN



2) HOLD THE HOSE

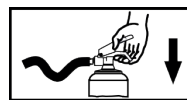

3) SQUEEZE GRIP LEVER



4) AIM THE JET AT BASE OF
FIRE

File name	Type of document	Fire Extinguisher Model	Date	Rele.	Check	Rev.	Pag.
23058-72_Technical manual	Use and Maintenance technical manual	23058-72	08/05/2023	M.R		0	4 di 7

23058-72: Portable Fire Extinguisher, 5 Kg Carbon Dioxide

- 2) Do not through the fire extinguisher on to the fire.
- 3) This fire extinguisher is a pressurized vessel and must not be pierced, dented or subjected to external damage.
- 4) Do not direct the extinguishing agent at another person.

5) STEPS AND FREQUENCY RELATED TO MAINTENANCE OPERATIONS

Note: The user have to complies to the national or international rules, if they are more restrictive of the below table

Table 2

Ref.	Periodicity	Step	Operations
5.1	12 Months	Inspection	Check the nominal charge by weighing the extinguisher.
5.2	10 Years	Hydrotest tank	Check the state of conservation and carry out the hydraulic test of the tank with special machinery. Is recommended the replacement of dispensing valve. N.B. : This procedure must be carried out by specialised staff, in certified laboratories.
5.3	*20 Years		Is recommended the replacement of fire extinguisher

*If it located in particular environments the timing can be reduced.
(it is recommended to reduce to 10 years)

N.B. : All the operations must be calculated from the date of placing on the market.
For the hydraulic test refer to the date stamped on the tank.





5.1) Inspection steps

1	Remove the fire extinguisher from the support and check the stability of the support fastening Check the condition of the marking label, replace if necessary.
2	Remove the horn/hose and check the correct internal passage with compressed air.
3	Check the safety seal and the safety pin conditions.
4	Check the nominal charge by weighing the cylinder. Before this operation, remove the accessories from the extinguisher (hose, horn etc.). Then use as references: – the tare weight indicated on the marking on the body of the extinguisher - the weight of the dispensing valve (~ 0,340 Kg)
5	Reinstall the accessories (horn, hose, etc...)
6	Record the inspection activity on the maintenance tag and on the fire protection register.

File name	Type of document	Fire Extinguisher Model	Date	Rele.	Check	Rev.	Pag.
23058-72_Technical manual	Use and Maintenance technical manual	23058-72	08/05/2023	M.R		0	5 di 7

23058-72: Portable Fire Extinguisher, 5 Kg Carbon Dioxide

Executive details Inspection steps

	<p>1 - Remove the extinguisher from the bracket and check: stability of the fastening support, cleaning and general conditions. Check the marking label and replace it if damaged.</p>		<p>2 - Remove the horn/hose and check the correct internal passage with compressed air.</p>
	<p>3 - Check safety pin and safety seal. Replace if necessary.</p>		<p>4 - Check the nominal charge by weighing the cylinder. Before this operation, remove the accessories from the extinguisher (hose, horn etc.). Then use as references: - the tare weight indicated on the marking on the body of the extinguisher; - the weight indicated in the body of the dispensing valve.</p>
<p>5 - Reinstall the relative accessories (horn, hose, ecc...). In this step check the plastic seal placed in the bindings of hose-valve and replace if necessary</p>		<p>6 - Record the activity on the maintenance tag and on the maintenance register</p>	

Note: illustrative image only

File name	Type of document	Fire Extinguisher Model	Date	Rele.	Check	Rev.	Pag.
23058-72_Technical manual	Use and Maintenance technical manual	23058-72	08/05/2023	M.R		0	6 di 7

23058-72: Portable Fire Extinguisher, 5 Kg Carbon Dioxide

5.2) Hydraulic test

At least every 10 years from the production date the fire extinguisher must be overhauled by a hydraulic pressure test in accordance with the pressure values "PT" stamped on the cylinder.

N.B.: This procedure must be carried out by specialised staff, in certified laboratories.

It is recommended the replacement of dispensing valve.

5.3) Twenty-year control

End-of-life fire extinguishers must be disposed in accordance with local waste management rules.

Before disposal or disassembly, the fire extinguisher MUST BE DEPRESSURIZED by a competent person.

Fire extinguishers should always be disposed of through an approved disposal company and in accordance with applicable local and national codes.

(see table 2 at point 5.3).

6) SPARE PARTS AND MAINTENANCE TOOLS

6.1) SPARE PARTS LIST

For the spare parts list see the table 1 at pag 3.

For more details see web site www.emme-italia.com

6.2) Inspection\Maintenance Tools

For a complete list of recommended tools see web site www.emme-italia.com.

It is recommended to use instruments with controlled calibration and periodically verified (at least every 12 months) with certified sample instrument.

File name	Type of document	Fire Extinguisher Model	Date	Rele.	Check	Rev.	Pag.
23058-72_Technical manual	Use and Maintenance technical manual	23058-72	08/05/2023	M.R		0	7 di 7